

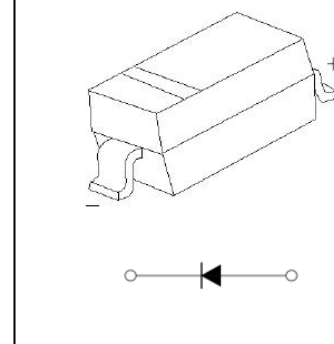

SOD-123 Plastic-Encapsulate Diodes

BAV19W~BAV21W SWITCHING DIODE

SOD-123



FEATURES

- Low Reverse Current
- Surface Mount Package Ideally Suited for Automatic Insertion
- Fast Switching Speed
- For General Purpose Switching Applications

MARKING:

BAV19W: A8

BAV20W: T2

BAV21W: T3

MAXIMUM RATINGS ($T_a=25^{\circ}\text{C}$ unless otherwise noted)

Symbol	Parameter	Value			Unit
		BAV19W	BAV20W	BAV21W	
V_{RM}	Non-Repetitive Peak Reverse Voltage	120	200	250	V
V_{RRM}	Peak Repetitive Reverse Voltage	100	150	200	V
V_{RWM}	Working Peak Reverse Voltage				
$V_{R(RMS)}$	RMS Reverse Voltage	71	106	141	V
I_o	Average Rectified Output Current	200			mA
I_{FSM}	Non-repetitive Peak Forward Surge Current @ $t=8.3\text{ms}$	1.7			A
P_D	Power Dissipation	500			mW
$R_{\theta JA}$	Thermal Resistance from Junction to Ambient	250			$^{\circ}\text{C}/\text{W}$
T_j	Junction Temperature	150			$^{\circ}\text{C}$
T_{stg}	Storage Temperature	-55~+150			$^{\circ}\text{C}$

ELECTRICAL CHARACTERISTICS($T_a=25^{\circ}\text{C}$ unless otherwise specified)

Parameter	Symbol	Test conditions	Min	Typ	Max	Unit
Reverse current	I_R	$V_R=100\text{V}$ BAV19W			0.1	μA
		$V_R=150\text{V}$ BAV20W			0.1	
		$V_R=200\text{V}$ BAV21W			0.1	
Forward voltage	V_F	$I_F=100\text{mA}$			1	V
		$I_F=200\text{mA}$			1.25	
Total capacitance	C_{tot}	$V_R=0\text{V}, f=1\text{MHz}$			5	pF
Reverse recovery time	t_{rr}	$I_F=I_R=30\text{mA}, I_{rr}=0.1*I_R, R_L=100\Omega$			50	ns

Typical Characteristics

BAV20W

